

# Discrete Surfaces for Architectural Design

Helmut Pottmann, Sigrid Brell-Cokcan,  
and Johannes Wallner

**Abstract.** Geometric problems originating in architecture can lead to interesting research and results in geometry processing, computer aided geometric design, and discrete differential geometry. In this article we survey this development and consider an important problem of this kind: Discrete surfaces (meshes) which admit a multi-layered geometric support structure. It turns out that such meshes can be elegantly studied via the concept of parallel mesh. Discrete versions of the network of principal curvature lines turn out to be parallel to approximately spherical meshes. Both circular meshes and the conical meshes considered only recently are instances of this meta-theorem. We discuss properties and interrelations of circular and conical meshes, and also their connections to meshes in static equilibrium and discrete minimal surfaces. We conclude with a list of research problems in geometry which are related to architectural design.

## §1. Introduction

Computer-Aided Geometric Design has been initiated by practical needs in the aeronautic and car manufacturing industries. Questions such as the digital storage of a surface design or the communication of freeform geometry to CNC machines served as motivation for the development of a solid theoretical basis and a huge number of specific methods and algorithms for freeform curve and surface design [18].

Another, related stream of research on surfaces in geometric modeling has been motivated by the animation and game industry. This area, nowadays often called ‘Geometry Processing’, focuses on discrete representations such as triangle meshes. By the nature of its main applications, it is driven by efficiency and visual appearance in animation and rendered scenes. Yet another topic is the construction of surfaces from 3D volumetric medical data like CT or MRI scans. The methods used there are

a blend of ideas from classical CAGD, Geometry Processing and Image Processing.

Certainly CAGD and Geometry Processing have common problems, such as the reconstruction of surfaces from 3D measurement data. But even there the expectations on the final surface, and also the data representation and algorithms may be quite different. This is only natural, given the different areas of applications.

New applications pose new problems and may stimulate interesting and rewarding mathematical research. It is the purpose of this paper to demonstrate this by means of *architectural design*. Architects use the best available CAD tools, but these systems do not optimally support their work. Just as an example, Frank O’Gehry employs developable surfaces, but CAD systems do not support this class of surfaces well. The reasons for using nearly developable surfaces are rooted in manufacturing and fabrication. In view of the large scale on which surfaces in architecture have to be built, it is obvious that the choice of the fabrication technique has an influence on the surface representation and on the design principle.

In the present survey we focus on *architectural design with discrete surface representations*. The basic surface representation is a mesh, but the fabrication poses constraints on the meshes to be used: These include planarity of faces, vertices of low valence, constraints on the arrangements of supporting beams and static properties, to name just a few. We will thus see that triangle meshes are hard to deal with, whereas quadrilateral or hexagonal meshes can fulfill these requirements more easily.

It turns out that important constraints have an elegant geometric expression in terms of *discrete differential geometry* [7, 14]. This field is currently emerging at the boundary of differential and discrete geometry and aims at discrete counterparts of geometric notions and methods which occur in the classical smooth theory. The latter then appears as a limit case, as discretization gets finer. In fact, some of the practical requirements in architecture already led to the development of new results in discrete differential geometry [22].

In this article we aim to demonstrate that discrete surfaces for architecture is a promising direction of research, situated at the meeting point of discrete and computational differential geometry, geometry processing, and architectural design. For our own work in that direction, see [9, 22, 28, 36]. For further geometric problems arising in architecture, we refer to our forthcoming book [30].

This paper is organized as follows: After a historical account on surfaces in architecture in Section 2, Section 3 formulates basic architectural requirements on discrete surfaces. We show why triangle meshes are harder to realize in an architectural design than quadrilateral or hexagonal meshes with planar faces. We also discuss the important fact that quadrilateral meshes with planar faces (called PQ meshes henceforth) are

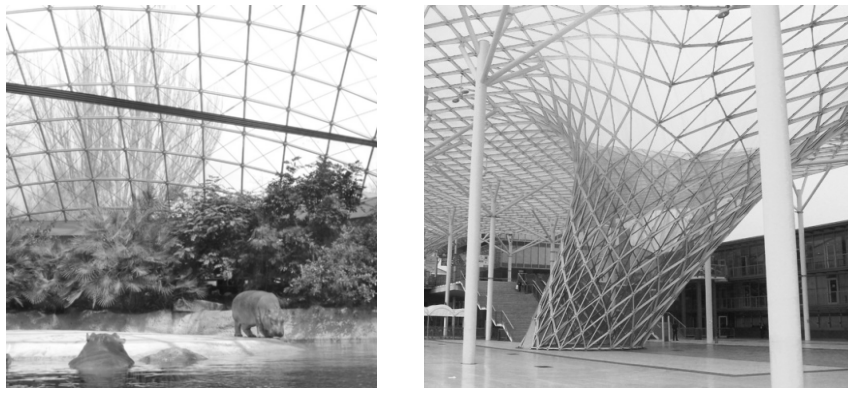

**Fig. 1.** Left: A PQ mesh in the Berlin zoo, by Schlaich Bergermann and Partners (Photo: Anna Bobenko). Right: Triangle mesh at the Milan trade fair, by M. Fuksas.

a discrete counterpart of so-called conjugate curve networks, and we provide an algorithm for computing PQ meshes. Section 4 discusses two types of PQ meshes, which discretize the network of principal curvature lines. These are the circular and conical meshes, which have an elegant theoretical basis in Möbius and Laguerre geometry, respectively. Section 5 deals with aspects of statics and functionality, and reports on some recent progress on PQ meshes in static equilibrium and on discrete minimal surfaces; these two topics turn out to be very closely related. Finally, Section 6 points to a number of open problems and indicates our plans for future research.

## §2. History of Multi-layered Freeform Surfaces in Architecture

Complex geometries and freeform surfaces appear very early in architecture – they date back to the first known dome-like shelters made from wood and willow about 400,000 years ago. Double curved surfaces have existed in domes and sculptural ornaments of buildings through the ages.

It was only in the 19th century that architects were granted a significant amount of freedom in their expression of forms and styles with industrialization and improved building materials such as iron, steel, and reinforced concrete (cf. François Coignet, ‘Béton aggloméré’, 1855). A similar milestone were the early 20th century fabrication methods for glass panels (Irving Colburn 1905, Emile Fourcault 1913, Max Bicheroux 1919).

Antoni Gaudi (1852–1926) achieved a deep understanding of statics and shape of freeform surfaces by using form-finding techniques and physical models. His *Sagrada Família* (1882–today) is the most prominent example.

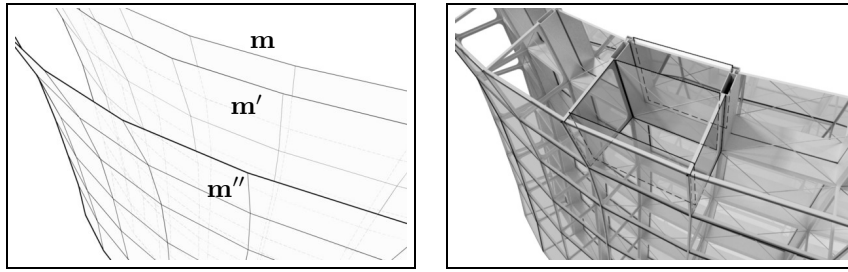

**Fig. 2.** Kunsthaus Graz. Left: the fluid body of the outer skin. Right: An interior view during construction, showing the triangulated and flat physical layers of the inner skin. Photo: Archive S. Brell-Cokcan.

Reinforced concrete seemed to be a good solution for sculptural forms and wide spans, with a peak of use in the 1960s, but its limitations were soon realized: weight, cost, and labour. Early attempts to reduce weight include segmentation of the desired surface into structural members and cladding elements. In 1914, the German architect Bruno Taut (1880-1938), used reinforced concrete girders as structural elements for his *Glass Pavilion*, with Luxfer glass bricks as glazing elements. Glass, as the epitome of ‘fluidity and sparkle’, and the ‘highest symbol of purity and death’, is the perfect material for Bruno Taut. Another successful solution by prefabrication are the spherical shells which form the roof of the Sydney opera house (1957–1973, by Jorn Utzen).

The evolution from iron to steel offered new dimensions and possibilities of prefabrication, as well as novel assembling logistics and material compositions for complex geometrical lightweight structures. Pioneers are Buckminster Fuller, famous for his geodesic domes, V.G. Suchov or Frei Otto, known for their suspended structures, and Schober and Schlaich, with their cable nets and grid shells (see [19, 33, 34, 35], and also Fig. 1). In general, geometric knowledge in combination with new methods of structural computation opens up new approaches to manufacturing and fabrication of freeform surfaces (cf. the *Gaussian Vaults* by Eladio Dieste, the *Sage Gateshead* (1997–2004) by Foster and Partners, or the developable surfaces of F. O’Gehry). *Triangular* meshes have been used whenever freeform surfaces cannot be easily planarized in another way. A recent example is the *Milan trade fair* roof by M. Fuksas (Fig. 1).

Optimization of geometry or structure is not the only reason for the search for a good segmentation of freeform surfaces (in CAD terms, this means a good way of meshing). Equally important are multifunctional



**Fig. 3.** A multi-layer construction (right) based on offset meshes  $m$ ,  $m'$ ,  $m''$  with planar quadrilateral faces (left).

requirements originating in building physics, and consequently the need for a multi-layered composition of the buildings' skin. Important questions here regard aesthetics as well as economic and structural viewpoints. Such a question could be: Is the mesh and the implied segmentation motivating the form in architectural terms? Is the mesh arbitrary, or supporting the form's dynamics, or is it perhaps doing the opposite?

A good example to mention here is the *Kunsthhaus Graz* (2000-2003, by P. Cook and C. Fournier) where the thickness of the buildings' skin ranges from 40cm up to 1m. *Kunsthhaus Graz* explicitly shows the different methods of meshing the 'inner' and 'outer' skin. While the 'outer' skin supports the fluid acrylic glass body with a rectangular mesh, the inner skin is a triangle mesh (see Fig. 2, right). The reason for this are economic considerations, which enforce flat surfaces for the buildings' physical layers.

For a good overview on contemporary architecture, containing a large number of geometrically remarkable designs, we refer to the book series "Architecture Now" [20].

### §3. Discrete Surfaces for Architectural Design

#### 3.1. Basic concepts

Multi-layered metal sheets and glass panel constructions used for covering roofing structures are expensive, complicated, or even impossible to bend. Therefore it is desirable to cover free-form geometry by *planar panel elements*, and use polyhedral surfaces, i.e., *meshes with planar faces* as our basic surface representation. Unless noted otherwise, in the following we always assume planarity of faces.

**Parallel meshes and offsets.** Many constructions in architecture are *layer composition constructions* where each layer has to be covered by planar panel elements (see e.g. Fig. 3, right). Geometry requirements are

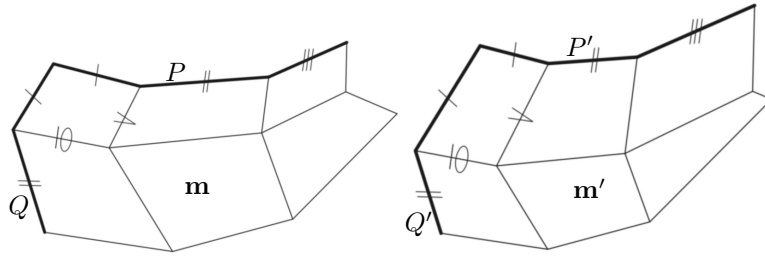

**Fig. 4.** In a pair of parallel meshes  $\mathbf{m}$ ,  $\mathbf{m}'$  with planar faces, corresponding edges and face planes are parallel. To construct a parallel mesh  $\mathbf{m}'$  of a quadrilateral mesh  $\mathbf{m}$  with planar faces, one may prescribe the images  $P'$ ,  $Q'$  to two polygons  $P$ ,  $Q$  (bold); the remaining part of  $\mathbf{m}'$  follows by parallelity.

present for all layers in the same way, and so meshes which possess exact *offset meshes* is an important topic of research.

Offset meshes are special *parallel meshes*. This concept is illustrated by Fig. 4: A mesh  $\mathbf{m}'$  is parallel to the mesh  $\mathbf{m}$ , if (i) both  $\mathbf{m}$ ,  $\mathbf{m}'$  have the same combinatorics; (ii) corresponding edges of  $\mathbf{m}$  and  $\mathbf{m}'$  are parallel; and (iii)  $\mathbf{m}$ ,  $\mathbf{m}'$  do not differ simply by a translation. It is a consequence of property (ii) that corresponding faces of  $\mathbf{m}$  and  $\mathbf{m}'$  are contained in planes which are parallel to each other.

**Supporting beams.** Planar panels have to be held together by a support structure, which is a composition of support beams arranged along the edges of the underlying mesh (see Fig. 5). A beam may be seen as a prismatic body, generated by a linear extrusion of a planar symmetric profile in a direction orthogonal to the profile plane (i.e., by extrusion along the longitudinal axis of the beam). The symmetry axis of the generator profile extrudes to a symmetry plane of the beam (the *central plane*, see Fig. 5). For most of our considerations, we will neglect the width of the beam, which is measured orthogonal to its central plane. We are mainly dealing with the slice of the beam lying in the central plane. This central plane shall always pass through an edge of the base mesh  $\mathbf{m}$ . We do not consider the case of torsion along the length of the beam, i.e., all our beams actually have a central plane.

**Optimized nodes and geometric support structure.** The higher the valence of a vertex, the more complicated it usually is to join the supporting beams there. Already the very simple case of a beam of width zero shows these complications: An *optimized node*  $\mathbf{v}$  is a mesh vertex where the central planes of all emanating beams pass through a fixed line, the *axis of the node*. The *geometric support structure* is formed by quadrilaterals lying in the central planes. It is assumed henceforth that

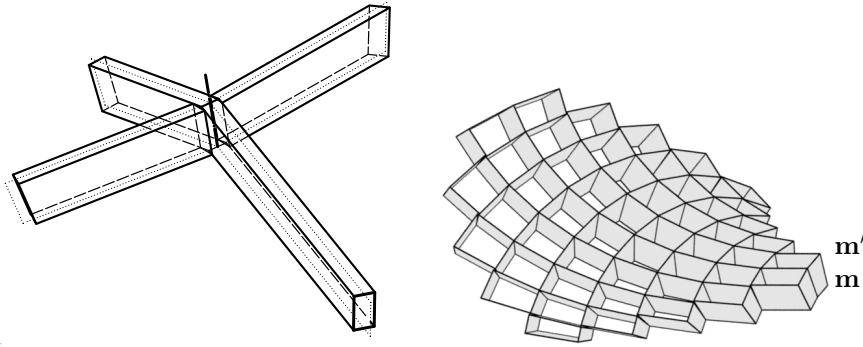

**Fig. 5.** *Left:* A supporting beam is symmetric with respect to its central plane. At an optimized node, the central planes of supporting beams pass through one straight line, which is called the node axis. If the node is not optimized, we speak of ‘geometric torsion in the node’. *Right:* A base mesh  $\mathbf{m}$  and its offset mesh  $\mathbf{m}'$  are the basis for construction of a geometric support structure with optimized nodes. The quadrilaterals shown here are trapezoids and lie in the central planes of the supporting beams. The offset pair of meshes shown in this figure has the particular property that corresponding vertices lie at constant distance. Further, corresponding faces are parallel at constant distance; see Section 4.3.

all nodes are optimized and hence three sides of the quadrilaterals in a geometric support structure are given by an edge  $e$  of  $\mathbf{m}$  and the two node axes at its ends. In most cases, the fourth edge  $e'$  is parallel to  $e$ , namely a corresponding edge of an offset mesh  $\mathbf{m}'$  of  $\mathbf{m}$ . Then, each of the quadrilaterals in the central planes is a trapezoid (see Fig. 5). Further, all node axes may be seen as discrete surface normals. We will see in the next subsection that especially for triangle meshes, optimization of all nodes may be impossible.

### 3.2. Triangle meshes

A substantial amount of research in geometry processing deals with triangle meshes and studies them from various perspectives. For instance, refinement is possible with subdivision algorithms, and smoothing is well understood. Although there are examples of the actual use of triangle meshes in architecture, they cause problems exactly in connection with the concepts discussed above, namely parallel meshes, offsets, and support structures. Let us discuss this in more detail.

**Proposition 1.** *A geometric support structure of a connected triangle mesh with optimized nodes can only be trivial: Either all axes of the nodes are parallel, or they pass through a single point.*

**Proof:** Consider a triangular face  $F$  of the mesh. Through each edge  $e_i$  of  $F$  we have a central plane  $C_i$  of a supporting beam ( $i = 1, 2, 3$ ). Because

nodes are optimized, the intersection lines  $C_1 \cap C_2, \dots$  of these three planes are the node axes. It follows that the three node axes at the three vertices of  $F$  pass through the point  $O = C_1 \cap C_2 \cap C_3$ , which possibly is at infinity. Any neighbour triangle has two node axes in common with  $F$ , so also all neighbour axes pass through  $O$ . By connectedness it follows that either all node axes of the mesh pass through a finite point  $O$ , or through an infinite point  $O$ , i.e., are parallel.  $\square$

For triangle meshes, also the concept of parallel meshes becomes trivial: Two triangles with parallel edges are connected by a similarity transformation. Hence, a parallel mesh  $\mathbf{m}'$  of a triangle mesh  $\mathbf{m}$  is just a scaled version of  $\mathbf{m}$ . Further, it is easy to see that any offset mesh  $\mathbf{m}'$  of  $\mathbf{m}$  arises from  $\mathbf{m}$  by uniform scaling from some center. It follows that only for near-spherical triangle meshes, an offset can be at approximately constant distance, and node axes can be approximately orthogonal to the mesh. For general freeform triangle meshes, there is no chance to construct a practically useful support structure with optimized nodes.

### 3.3. Beyond triangle meshes

The higher the number of edges in a planar face, the more flexibility we have when constructing parallel meshes. This in turn implies more flexibility in the construction of support structures, as shown by the following result, which relates support structures and parallel meshes (see [9]).

**Proposition 2.** *Any geometric support structure of a simply connected mesh  $\mathbf{m}$  with planar faces and non-parallel node axes can be constructed as follows: Consider a parallel mesh  $\mathbf{m}^0$  of  $\mathbf{m}$  and a point  $O$  and let the node axis  $N_i$  at the vertex  $\mathbf{m}_i$  be parallel to the line  $N_i^0 = O\mathbf{m}_i^0$ .*

**Proof:** Given the axes  $N_i$ , we consider axes  $N_i^0$  parallel to  $N_i$ , but passing through a fixed point  $O$ . Generally, if  $N_i, N_j$  lie in the same central plane  $C_{ij}$ , the corresponding lines  $N_i^0, N_j^0$  span a plane  $C_{ij}^0$  parallel to  $C_{ij}$ . We may now construct a parallel mesh  $\mathbf{m}^0$  of  $\mathbf{m}$ . On one of the new lines, say  $N_k^0$ , we choose a vertex  $\mathbf{m}_k^0$ . We take a face adjacent to  $\mathbf{m}_k$  and construct the corresponding face adjacent to  $\mathbf{m}_k^0$  by the requirement that face planes are parallel, and for any vertex  $\mathbf{m}_i$ , the corresponding vertex  $\mathbf{m}_i^0$  lies in  $N_i^0$ . Thus the new face is constructed by intersecting lines with a plane, and the edges of the new face (lying in the planes  $C_{ij}^0$ ), are, by construction, parallel to the edges of the original face. In this way step by step, in rings around the vertex  $\mathbf{m}_k^0$ ,  $\mathbf{m}^0$  is produced.  $\square$

### 3.4. Quadrilateral meshes with planar faces

Gehry Partners and Schlaich Bergermann and Partners [19, 35] give a number of reasons why planar quadrilateral elements are preferable over



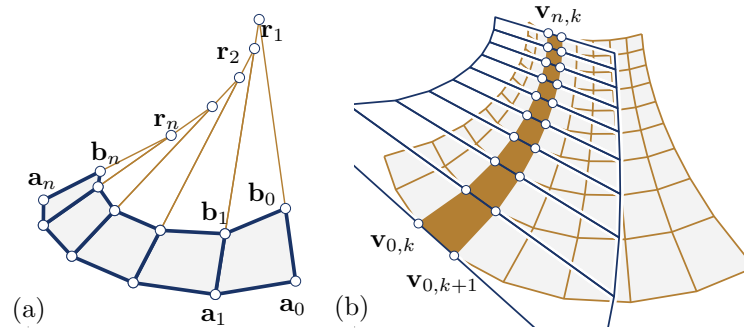

**Fig. 6.** (a) PQ strip as a discrete model of a developable surface. (b) Discrete developable surface tangent to PQ mesh along a row of faces.

triangular panels (cf. Fig. 1). The planarity constraint on the faces of a quad mesh however is not so easy to fulfill, and in fact there is only little computational work on this topic. So far, architecture has been mainly concentrating on shapes of simple genesis, where planarity of faces is automatically achieved [19, 35]. For example, *translational meshes*, generated by the translation of a polygon along another polygon, have this property: In such a mesh, all faces are parallelograms and therefore planar.

**Prior work in discrete differential geometry.** The geometry of quadrilateral meshes with planar faces (*PQ meshes*) has been studied within the framework of *difference geometry*, which is a precursor of discrete differential geometry [7, 14]. It has been observed that such meshes are a discrete counterpart of conjugate curve networks on smooth surfaces. Earlier contributions are found in the work of R. Sauer from 1930 onwards, culminating in his monograph [32]. Recent contributions, especially on the higher dimensional case, include the work of Doliwa, Santini and Mañas [16, 17, 23]. In the mathematical literature, PQ meshes are sometimes simply called *quadrilateral meshes*.

**PQ strips as discrete developable surfaces.** The simplest PQ mesh is a *PQ strip*, a single row of planar quadrilateral faces. The two rows of vertices are denoted by  $\mathbf{a}_0, \dots, \mathbf{a}_n$  and  $\mathbf{b}_0, \dots, \mathbf{b}_n$  (see Fig. 6). It is obvious and well known that such a mesh is a discrete model of a developable surface [27, 32]. This surface is cylindrical, if all lines  $\mathbf{a}_i\mathbf{b}_i$  are parallel. If the lines  $\mathbf{a}_i\mathbf{b}_i$  pass through a fixed point  $\mathbf{s}$ , we obtain a model for a conical surface with vertex  $\mathbf{s}$ . Otherwise the PQ strip is a patch on the ‘tangent surface’ of a polyline  $\mathbf{r}_1, \dots, \mathbf{r}_n$ , as illustrated by Fig. 6.

This model is the direct discretization of the well known fact that in general developable surfaces are patches in the tangent surfaces of space curves. The lines  $\mathbf{r}_i\mathbf{r}_{i+1}$  serve as the rulings of the discrete tangent surface,

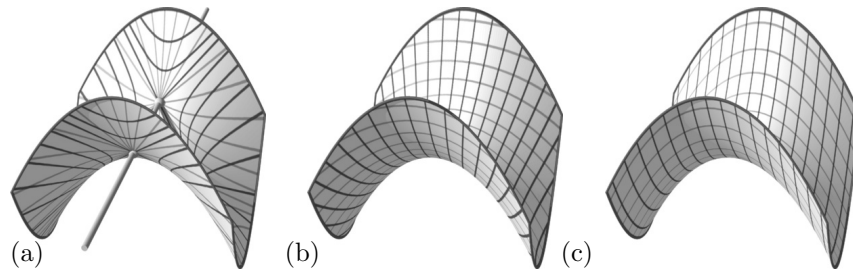

**Fig. 7.** Different networks of conjugate curves. From left: epipolar curves, principal curvature lines, and generator curves of a translational surface.

which carries the given PQ strip. The planar faces of the strip represent tangent planes of the developable surface.

**PQ meshes discretize conjugate curve networks.** We now consider a PQ mesh which is a regular grid, with vertices  $\mathbf{v}_{i,j}$ ,  $i = 0, \dots, n$ ,  $j = 0, \dots, m$  (In practice, meshes will have vertices of valence  $\neq 4$ , which can be treated like singularities). The relation between such PQ meshes and *conjugate curve networks* is established as follows: Recall that two families of curves are conjugate, if and only if the tangents to family A along each curve of family B constitute a developable surface [27]. Obviously, a PQ mesh has the property that the edges transverse to one sub-strip constitute a discrete developable surface (see Fig. 6). Thus, grid-like PQ meshes discretize conjugate curve networks, with the grid polylines corresponding to the curves of the network. This relation shows both the degrees of freedom and the limiting factors in the construction of PQ meshes (for more details see [22]). Therefore, conjugate networks of curves may serve as a guide for the design of PQ meshes, provided the curves involved intersect transversely. Examples are the principal curvature lines (see Fig. 7b), the generating curves of a translational surface (used in architectural design [19, 35], see Fig. 7c), epipolar curves (see [12] and Fig. 7a), and the family of isophotes w.r.t. the  $z$  axis together with the family of curves of steepest descent [25].

**An algorithm for planarization.** Liu et al. [22] proposed an algorithm which solves the following problem: Given a quad mesh with vertices  $\mathbf{v}_{ij}$ , minimally perturb the vertices into new positions such that the resulting mesh is a PQ mesh. They minimize a functional which expresses fairness and closeness to the original mesh subject to the planarity condition. In order to express planarity of a quad  $Q_{ij}$ , one considers the four angles  $\phi_{ij}^1, \dots, \phi_{ij}^4$  enclosed by the edges of the quad, measured in the interval  $[0, \pi]$ . It is known that  $Q_{ij}$  is planar and convex if and only if

$$\phi_{ij}^1 + \dots + \phi_{ij}^4 = 2\pi. \quad (1)$$

For input meshes not too far away from conjugate curve networks this algorithm works very well. However, there is no reason to expect good results with arbitrary input meshes. Mesh directions close to asymptotic (self-conjugate) directions of an underlying smooth surface cause heavy distortions and are usually useless for applications.

**Combining subdivision and planarization.** A practically useful and stable method for generating PQ meshes from coarse control meshes is achieved by a combination of the planarization algorithm with a quad-based subdivision algorithm like Doo-Sabin or Catmull-Clark [22]: One subdivides a given mesh. Since this operation introduces non-planar faces, one then applies planarization. These two steps are iterated to generate a hierarchical sequence of PQ meshes (see Fig. 10). Applying this method just to a PQ strip yields a powerful method for modeling with developable surfaces [22], which is also interesting for architecture.

In Section 4 we turn to two remarkable classes of PQ meshes. Both of them discretize the network of principal curvature lines. They possess offsets and support structures. Their computation can also be based on constrained optimization and subdivision, but one needs a stronger constraint than just planarity of faces.

### 3.5. Hexagonal meshes and other patterns

The less edges per vertex, the more flexibility we have in the construction of parallel meshes and support structures. Furthermore, lower valence makes fabrication of nodes easier. This topic is not yet well explored, even if there is some initial work by B. Cutler [13]. We would also like to mention that *subdivision*, for hexagonal meshes and other patterns, without planarity constraints, and focusing on applications in the arts, has been used by E. Akleman [1, 2, 3].

## §4. Principal Meshes in their Circular and Conical Incarnations

This section deals with *circular* and *conical* PQ meshes, which have particularly interesting properties for applications in architectural design. In a circular mesh, all quadrilaterals have a circumcircle, whereas in a conical mesh, the faces adjacent to a vertex are tangent to a right circular cone. Both circular and conical meshes discretize the network of principal curvature lines, thus representing fundamental shape characteristics. Both possess exact offsets: circular meshes have vertex offsets, whereas conical meshes possess face offsets. We will approach these two types of meshes via the theory of parallel meshes [28]. This allows easy access to discrete surface normals, offsets, and support structures.

Let us first think about *discretizations of the network of principal curvature lines*. Since this is a conjugate curve network, we use a PQ mesh to

discretize it. It is interesting that there is a rather general characterization of *principal* PQ meshes:

**Meta-Theorem.** *A quad mesh  $\mathbf{m}$  with planar faces may be seen as a principal mesh, i.e., a discrete analogue of the network of principal curvature lines on a smooth surface, if it possesses a parallel mesh  $\mathbf{m}^0$  which approximates a sphere. In this case the discrete normals defined by means of the auxiliary mesh  $\mathbf{m}^0$  according to Proposition 2 have the property that normals at neighbour vertices are co-planar.*

**Proof:** Recall that a curve  $c$  in a surface is a principal curvature line if and only if the surface normals along that curve form a developable surface [27]. Now we say that grid polylines of a regular PQ mesh are principal curvature lines in a discrete sense, if the normals associated with neighbouring vertices are co-planar (cf. Fig. 6). In the terminology of the general discussion above, this means that the normals are suitable axes of a geometric support structure with optimized nodes, and Proposition 2 implies the existence of a parallel mesh  $\mathbf{m}^0$ , whose vertices (interpreted as vectors) indicate the normals of the mesh  $\mathbf{m}$ . As  $\mathbf{m}$  and  $\mathbf{m}^0$  are parallel meshes, the lines connecting the origin of the coordinate system with the vertices of  $\mathbf{m}^0$  are discrete normals of the mesh  $\mathbf{m}^0$ , too. Therefore,  $\mathbf{m}^0$  is a mesh which is approximately orthogonal to a bundle of lines, i.e., which is approximately spherical.  $\square$

Both the statement and the proof of this result are vague because there is no exact definition of ‘discrete normal’. A more restrictive definition of ‘discrete normal’ simultaneously restricts the class of principal meshes. The meta-theorem may be extended to relative differential geometry, where a general convex surface takes the role of a sphere [29].

#### 4.1. Circular meshes

Circular meshes have been introduced by Martin et al. [24]. They are known to be a discrete analogue of the network of principal curvature lines (not only in the sense of the meta-theorem) and have been the topic of various contributions from the perspective of discrete differential geometry and integrable systems [6, 7, 5, 11, 21]. The following result, which shows that circular meshes are indeed related to meshes which approximate a sphere, is shown in [21] and [28]:

**Theorem 1.** *A PQ mesh  $\mathbf{m}$  which possesses an offset mesh  $\mathbf{m}'$  such that corresponding vertices of  $\mathbf{m}$  and  $\mathbf{m}'$  lie at constant distance, is a circular mesh. Any circular mesh is parallel to a mesh  $\mathbf{m}^0$  whose vertices lie in a sphere.*

In view of the meta-theorem, a circular meshes  $\mathbf{m}$  is a principal mesh. It has an offset mesh  $\mathbf{m}'$  and therefore also a support structure. In case

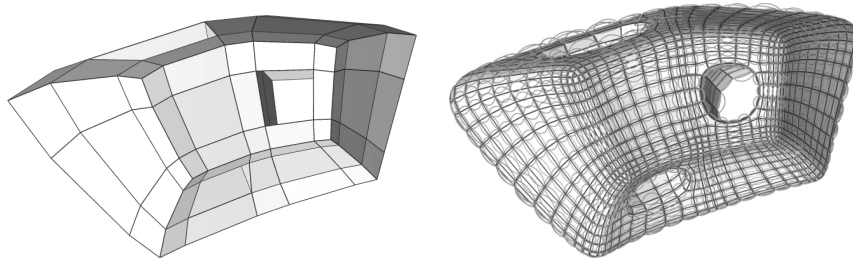

**Fig. 8.** The circular mesh at right has been constructed from the base mesh (left) by a combination of Doo-Sabin subdivision and circular optimization.

$\mathbf{m}'$  is at constant vertex distance, the support structure defined by joining  $\mathbf{m}$  with  $\mathbf{m}'$  has the property that the segments on the node axes are of constant length.

The computation of circular meshes may be based on a combination of planarization and subdivision (see Fig. 8), but one has to replace the planarity constraint (1) by two constraints per face, which express the existence of a circumcircle:

$$\phi_{ij}^1 + \phi_{ij}^3 - \pi = \phi_{ij}^2 + \phi_{ij}^4 - \pi = 0. \quad (2)$$

Finally, let us mention that circular meshes, considered as a collection of vertices, are a concept of Möbius geometry. A Möbius transformation maps a circular mesh to another circular mesh.

#### 4.2. Conical meshes

Whereas circular meshes have been known for some time, their conical counterparts have been introduced only recently [22], motivated by geometric problems in architecture: We demand principal meshes which have *offsets at constant face/face distance*. Also the conical meshes are an instance of the meta-theorem.

**Theorem 2.** *A PQ mesh  $\mathbf{m}$  which possesses an offset mesh  $\mathbf{m}'$  such that corresponding oriented face planes of  $\mathbf{m}$  and  $\mathbf{m}'$  lie at constant signed distance, is a conical mesh. Any conical mesh is parallel to a mesh  $\mathbf{m}^0$  whose face planes are tangent to a sphere.*

**Proof (Sketch):** This is shown in [28], but we repeat the main argument concerning the construction of  $\mathbf{m}^0$  from  $\mathbf{m}$ , because it is easy: We take all face planes of a conical mesh  $\mathbf{m}$  and translate them such that they are tangent to the unit sphere. Faces adjacent to a vertex are tangent to a circular cone (see Fig. 9), and obviously do not lose this property with the translation – the cone axis after translation passes through the origin. It

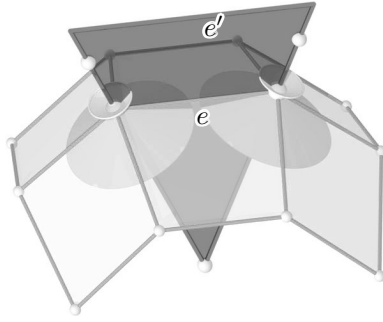

**Fig. 9.** In a conical mesh  $\mathbf{m}$ , the four face planes incident to a vertex are tangent to a right circular cone. The cone axes are discrete surface normals. An edge  $e$  of  $\mathbf{m}$ , the cone axes at the two end points of  $e$ , and the corresponding edge of an offset mesh form a trapezoid, which lies in the bisector plane of the two face planes meeting at  $e$ . A collection of such trapezoids constitute a geometric support structure for  $\mathbf{m}$ , as shown by Fig. 5.

follows that the translated planes carry the faces of a mesh  $\mathbf{m}^0$  which is circumscribed to the unit sphere. The discrete normals of  $\mathbf{m}$  are the cone axes.  $\square$

The computation of conical meshes and applications in architecture has been discussed by Liu et al. [22]. This is based on a simple criterion, shown in [37], which ensures that a vertex in a PQ mesh is conical, i.e., the adjacent faces are tangent to a right circular cone.

**Proposition 3.** *A quad mesh (grid case) is conical if and only if for all vertices, the four interior angles  $\omega_1, \dots, \omega_4$  successively enclosed by the edges emanating from that vertex obey  $\omega_1 + \omega_3 = \omega_2 + \omega_4$ .*

Conical meshes, viewed as sets of oriented face planes, are an object of Laguerre geometry. A Laguerre transformation maps a conical mesh onto a conical mesh. However, one has to admit degenerate cases of the tangent cones at the vertices. For a more thorough discussion of this subject, see [28].

### 4.3. The relation between circular and conical meshes

Both circular and conical meshes are discretizations of the network of principal curvature lines; the former is a Möbius geometric concept, the latter is based on Laguerre geometry. Lie sphere geometry [10] is a geometry which subsumes both of these geometries. As Lie sphere transformations preserve principal curvature lines (viewed as sets of contact elements), it is natural to treat circular and conical meshes together. This unifying viewpoint of Lie sphere geometry is assumed by Bobenko and Suris in the recent paper [8].

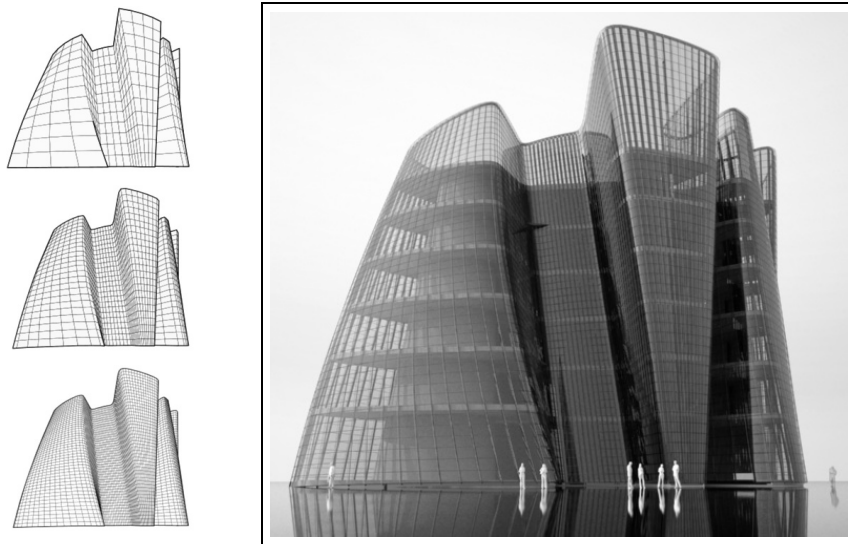

**Fig. 10.** A sequence of conical meshes (at left) produced by subdivision and mesh optimization according to [22], which is the basis of the (incomplete, especially roofless) architectural design at right. Images: B. Schneider.

Even if we do not use these concepts of ‘higher geometry’, we can still find close relations between circular and conical meshes, which are expressed in terms of Euclidean geometry. One of the results in this direction contained in [28] is the following:

**Theorem 3.** *For each conical mesh  $\mathbf{l}$  with face planes  $F_{ij}$  (regular grid case) there is a two-parameter family of circular meshes  $\mathbf{m}$  whose vertices lie in the face planes of  $\mathbf{l}$  and are symmetric with respect to the edges of  $\mathbf{l}$ . Cone axes of the mesh  $\mathbf{l}$  coincide with circle axes of the mesh  $\mathbf{m}$ .*

**Proof (Sketch):** We choose a face  $F_{00}$  and place a seed vertex  $\mathbf{m}_{00}$  in it. More vertices of  $\mathbf{m}$  are constructed by reflecting already existing vertices in the symmetry planes which are attached to the edges of  $\mathbf{l}$  (see Fig. 9). These symmetry planes contain the cone axes at the vertices. If we consider only the intrinsic geometry of the mesh, this is something like reflection in the edge itself.

It is not difficult to see, e.g., from Fig. 11, that successive reflection of a point in the four edges which emanate from a vertex  $\mathbf{l}_{ij}$  yields the point we started with, so this construction unambiguously places a new vertex  $\mathbf{m}_{ij}$  into every face  $F_{ij}$ . For details, see [28].  $\square$

There are meshes which are both circular and conical, i.e., possess vertex offsets and face offsets. Particularly interesting is the question of

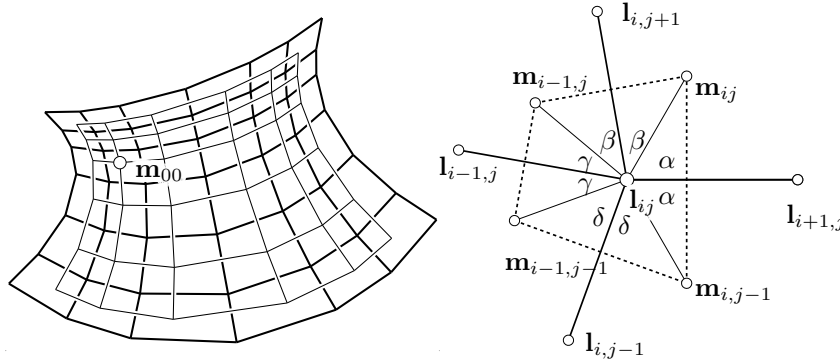

**Fig. 11.** Left: Construction of a circular mesh (thin lines) from a conical mesh (bold lines) by successive reflection of a vertex  $\mathbf{m}_{00}$  in the edges of the conical mesh. Right: Top view in the direction of the cone axis at  $\mathbf{l}_{ij}$ .

finding a mesh  $\mathbf{m}$  having an offset  $\mathbf{m}'$  which is both a vertex offset and face offset. Such a mesh can be constructed in an elegant way via a parallel mesh  $\mathbf{m}^0$  whose vertices lie on a sphere and whose face planes touch another, concentric, sphere. This implies that the circumcircles of  $\mathbf{m}^0$  have a constant radius and thus they are diagonal meshes of rhombic meshes  $\mathbf{r}$  with vertices on a sphere; the meshes  $\mathbf{r}$  are formed by skew quads with constant edge length. An example of such a mesh  $\mathbf{m}$  is given in Fig. 5. These meshes are also closely related to the discrete representations of surfaces with constant negative Gaussian curvature studied by W. Wunderlich and R. Sauer [31, 38].

We would like to point out that the concepts of circular and conical meshes become trivial or too restrictive if we try to apply them to other meshes, e.g., to triangle meshes or hexagonal meshes. For a hexagonal mesh, the generic valence of a vertex is 3 and hence it is always conical. In contrast, a hexagonal mesh all of whose faces have a circumcircle must have all of its vertices on a sphere. Likewise, a triangle mesh is always circular, but it is only conical if all its face planes are tangent to a sphere.

## §5. Aspects of Statics and Functionality

This section briefly reports on properties of meshes connected to equilibrium forces, and on discrete minimal surfaces. These two topics are connected, as discussed more thoroughly in [36].

### 5.1. PQ meshes in static equilibrium

Consider a framework of rods connected together with spherical joints. Mathematically speaking, such a framework consists of collections of vertices and edges. We assume that in some vertices external forces are



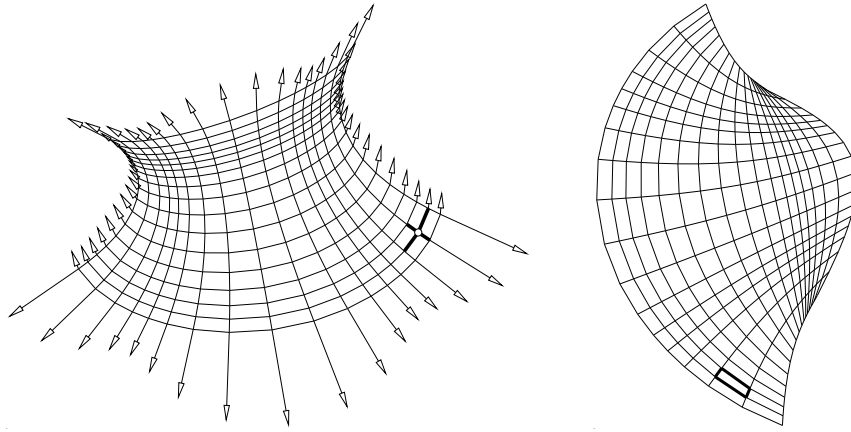
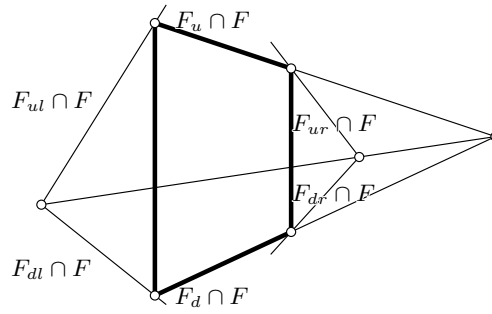

**Fig. 12.** Left: A mesh which has equilibrium forces. Only the external forces are shown. These forces are the edges of a mesh which is reciprocal-parallel to the first one (at right, not to scale). The edges shown in bold correspond to each other and thus illustrate the fact that a mesh and its reciprocal-dual mesh are combinatorial duals. Both meshes are discrete minimal surfaces, and the left hand mesh is conical.

applied. A system of internal forces is an assignment of a pair of opposite forces to each edge, one for either end. Such a system of forces is in equilibrium if for each vertex the sum of forces equals zero. Fig. 12 illustrates this for a rectangular piece of quadrilateral mesh. Obviously the zero sum condition means that the forces acting upon a vertex can be taken as the boundary edges of a face in a new quad mesh, which is then called *reciprocal-parallel* to the original one [32]. The first ones in the following list of properties of forces and reciprocal-parallel meshes are obvious, for the rest we refer to [32] and [36]. The property of having equilibrium forces is denoted for short by ‘EF’.

- The reciprocal-parallel relation is symmetric (disregarding boundaries).
- A PQ mesh is EF  $\iff$  it has a reciprocal-parallel mesh
- If a mesh has property E, then so do all parallel meshes.
- A mesh reciprocal-parallel to a PQ mesh has planar vertex stars.
- A PQ mesh is EF  $\iff$  it is *infinitesimally flexible* [32, 36]
- A PQ mesh is EF  $\iff$  it has the property of Fig. 13 [32, 36].
- A conical mesh is EF  $\iff$  its spherical image is *isothermic* [36].

The last property mentioned leads into the next subsection, which discusses discrete minimal surfaces. The reader interested in definition, properties, and previous work on isothermic meshes is referred to [36].



**Fig. 13.** For a PQ mesh, the existence of a reciprocal-parallel mesh (or of equilibrium forces) is characterized by an incidence property of the lines of intersection of every face  $F$  with its neighbours. The notation in the figure indicates relative position with lower indices:  $l, r, u, d$  mean left, right, up, and down, respectively. This is the Desargues configuration of projective geometry.

## 5.2. Discrete minimal surfaces

In the smooth category, minimal surfaces are curvature-continuous surfaces with vanishing mean curvature [15]. For various reasons, their mathematical theory is very rich. One is that they occur as solutions of a prominent nonlinear optimization problem (minimizing surface area under given boundary conditions), another one is that there is an almost 1-1 correspondence between minimal surfaces and holomorphic functions. We note only one further property: Minimal surfaces are isothermic, i.e., they possess a curvature line parametrization  $\mathbf{g}(u, v)$ , such that not only  $\frac{\partial \mathbf{g}}{\partial u} \cdot \frac{\partial \mathbf{g}}{\partial v} = 0$ , but also  $\|\frac{\partial \mathbf{g}}{\partial u}\| = \|\frac{\partial \mathbf{g}}{\partial v}\|$ .

In the discrete category, this picture changes a bit. ‘The’ definition of a discrete minimal surface does not exist, because each of the various properties of smooth minimal surfaces can be discretized, and the discrete representation of data plays an important role. A particular discretization is worth studying if it transfers more than just one continuous property to the discrete setting. Another reason of interest for a particular construction is that the resulting discrete theory is very rich.

One possible choice of property and data representation is *triangle meshes which minimize surface area* under given boundary conditions. They have been studied by K. Polthier [26]. Another fruitful combination is *PQ meshes which are discrete-isothermic*, investigated by A. Bobenko and coworkers [6]. They called a mesh isothermic, if it is circular, and for each face, the cross ratio of the four vertices, computed with respect to their circumcircle, equals  $-1$ . As it turns out, this is a discrete version of the defining property of isothermic surfaces mentioned above.

The work on isothermic meshes and related concepts recently culminated in the construction of discrete so-called  $s$ -isothermic minimal surfaces with prescribed combinatorics [5]. Our own work in that direction [36] includes conical meshes in the shape of minimal surfaces, which are intimately connected with the isothermic meshes of [6], and their reciprocal-parallel meshes, which are discrete minimal surfaces in their own right. Examples of such constructions are shown by Fig. 12.

### §6. Open Problems and Future Work

In this paper we have addressed a few problems which are motivated by practical requirements in architectural design. Their solution leads to remarkable discrete surface representations, some of which have been unknown so far in discrete differential geometry. We believe that there is a significant potential for further research in this area, which encompasses problems originating in architectural design, geometry processing, and discrete differential geometry. Topics of future research include the following:

- We need new and intuitive tools for the design of PQ meshes. Since PQ meshes discretize conjugate curve networks, a possible approach would be an interactive method for the design of conjugate curve networks, where the network curves ‘automatically’ avoid asymptotic directions, and consequently intersect transversely. These curve networks can then be used to construct quad meshes capable of PQ optimization.
- It is necessary to continue to study parallel meshes in general, especially with regard to computation, design, and meshes with special properties parallel to a given mesh.
- Hexagonal meshes and other patterns should be investigated.
- We have seen that conical and circular meshes have face offsets and vertex offsets, respectively. We are currently investigating the beautiful geometry of those meshes (not only quad meshes) which possess edge offsets. For architecture, these meshes have the attractive property that their support structure may be built from beams of constant height. Initial results on quad meshes with edge offsets may be found in [29].
- In architectural design, the aesthetic value of meshes is of great importance. It is natural to employ geometric functionals and consider their minimizers. Minimal surfaces are an example, but more work is needed in this area. Obvious candidates to investigate are discrete Willmore surfaces represented as circular meshes (this is a question of Möbius geometry). Likewise, we could search for conical meshes representing Laguerre-minimal surfaces. The reader interested in these topics is referred to the monograph by W. Blaschke [4] for the continuous case.

From the architectural viewpoint, there are the following issues in connection with freeform surfaces:

- Optimization should not neglect statics and structural considerations.
- The climate inside glass structures demands separate attention. Geometric questions which occur here have to do with light and shade, the possibility of shading systems tied to support structures, and even a layout of supporting beams with regard to shading. Also the aesthetic component is present here at all times.
- The difficult geometric optimization of freeform surfaces which supports the architectural design process;
- The demand for planar segments without the appearance of an overall polygonalisation;
- Generally speaking, the ‘right’ choice of an overall segmentation of a multi-layered building skin with a good planar mesh;
- The complexity of joints, especially the absence of so-called geometric torsion in the nodes (cf. Fig. 5, left).

In conclusion, we believe that architecture may be viewed as a rich source for interesting and rewarding research problems in applied geometry.

**Acknowledgments.** This research has been supported by grants No. S9206-N12 and No. P19214-N18 of the Austrian Science Fund (FWF).

### References

1. Akleman, E., V. Srinivasan, and E. Mandal, Remeshing Schemes for Semi-Regular Tilings. In *Proc. Shape Modeling International 2005*.
2. Akleman, E., V. Srinivasan, Z. Melek and P. Edmundson, Semi-regular Pentagonal Subdivisions, in *Shape Modeling International 2004*, IEEE Computer Society, 2004.
3. Akleman, E., and V. Srinivasan, Honeycomb Subdivision, In *Proc. 17th Int. Symp. Computer & Information Sc.*, 2002, 137–141.
4. Blaschke, W., *Vorlesungen über Differentialgeometrie*, volume 3, Springer, 1929.
5. Bobenko, A., Hoffmann, T. and B. Springborn, Minimal surfaces from circle patterns: Geometry from combinatorics, *Annals of Math.* **164** (2006), 231–264.
6. Bobenko, A., and U. Pinkall, Discrete isothermic surfaces, *J. Reine Angew. Math.* **475** (1996), 187–208.
7. Bobenko, A., and Yu. Suris, *Discrete differential geometry. Consistency as integrability*, arXiv preprint *math.DG/0504358*, 2005.

8. Bobenko, A., and Yu. Suris, On organizing principles of discrete differential geometry, technical report, August 2006.
9. Brell-Cokcan, S., and H. Pottmann, *Tragstruktur für Freiformflächen in Bauwerken*. Patent No. A1049/2006 pending.
10. Cecil, T., *Lie Sphere Geometry*, Springer, 1992.
11. Cieśliński, J., Doliwa, A. and P. M. Santini, The integrable discrete analogues of orthogonal coordinate systems are multi-dimensional circular lattices, *Phys. Lett. A* **235** (1997), 480–488.
12. Cipolla, R., and P. Giblin, *Visual Motion of Curves and Surfaces*, Cambridge University Press, 2000.
13. Cutler, B., and E. Whiting, Constrained planar remeshing for architecture, poster presentation, Symp. Geom. Processing, 2006.
14. Desbrun, M., E. Grinspun (organizers), and P. Schröder, K. Polthier et al. *Discrete differential geometry*, SIGGRAPH Course Notes, 2006.
15. do Carmo, M., *Differential Geometry of Curves and Surfaces*, Prentice-Hall, 1976.
16. Doliwa, A., and P. M. Santini, Multidimensional quadrilateral lattices are integrable, *Phys. Lett. A* **233** (1997), 365–372.
17. Doliwa, A., P. M. Santini, and M. Mañas, Transformations of quadrilateral lattices, *J. Math. Phys.* **41** (2000), 944–990.
18. Farin, G., A history of curves and surfaces in CAGD, in *Handbook of Computer Aided Geometric Design*, G. Farin, J. Hoschek and M.-S. Kim, eds., Elsevier, 2002, 1–21.
19. Glymph, J., D. Shelden, C. Ceccato, J. Mussel, and H. Schober, A parametric strategy for freeform glass structures using quadrilateral planar facets, In *Acadia 2002*, ACM, 303–321.
20. Jodidio, P., *Architecture Now*, volumes 1–4, Taschen, 2000–2006.
21. Konopelchenko, B. G., and W. K. Schief, Three-dimensional integrable lattices in Euclidean spaces: conjugacy and orthogonality, *Proc. Roy. Soc. London Ser. A* **454** (1998), 3075–3104.
22. Liu, Y., H. Pottmann, J. Wallner, Y. Yang, and W. Wang, Geometric modeling with conical meshes and developable surfaces, *ACM Trans. on Graphics* **25**/3 (2006), 681–689.
23. Mañas, M., A. Doliwa, and P. M. Santini, Darboux transformations for multidimensional quadrilateral lattices I, *Phys. Lett. A* **232** (1997), 99–105.
24. Martin, R. R., J. de Pont, and T. J. Sharrock, Cyclide surfaces in computer aided design, in *The mathematics of surfaces*, J. A. Gregory, ed., Clarendon Press, Oxford, 1986, 253–268.
25. Poeschl, T., Detecting surface irregularities using isophotes, *Comput. Aided Geom. Design* **1** (1984), 163–168.

26. K. Polthier, *Polyhedral surfaces of constant mean curvature*. Habilitationsschrift TU Berlin, 2002.
27. Pottmann, H., and J. Wallner, *Computational Line Geometry*, Springer, 2001.
28. Pottmann, H., and J. Wallner, The focal geometry of circular and conical meshes, Geometry preprint 163, TU Wien, 2006.
29. Pottmann, H., Generalized principal meshes and their support structures, Geometry Preprint 158, TU Wien, 2006.
30. Pottmann, H., A. Asperl, M. Hofer, and A. Kilian, *Geometry for Architecture*, Bentley Press, 2007.
31. Sauer, R., Parallelogrammgitter als Modelle pseudosphärischer Flächen, Math. Z. **52** (1950), 611–622.
32. Sauer, R., *Differenzengeometrie*, Springer, 1970.
33. Schober, H., Netzkuppeln mit ebenen Maschen, Beratende Ingenieure **28** (1998), 15–19.
34. Schober, H., Geometrie-Prinzipien für wirtschaftliche und effiziente Schalenträgerwerke, Bautechnik **79** (2002), 16–24.
35. Schober, H., Freeform glass structures, In *Proc. Glass Processing Days*, 2003, 46–50.
36. Wallner, J., and H. Pottmann, Infinitesimally flexible meshes and discrete minimal surfaces, Geometry preprint 162, TU Wien, 2006.
37. Wang, W., J. Wallner, and Y. Liu, An angle criterion for conical mesh vertices, Geometry preprint 157, TU Wien, 2006.
38. Wunderlich, W., Zur Differenzengeometrie der Flächen konstanter negativer Krümmung, Sitz. Österr. Akad. Wiss. **160** (1951), 41–77.

Helmut Pottmann and Johannes Wallner  
Institute of Discrete Mathematics and Geometry, TU Wien  
Wiedner Hauptstr. 8–10/104  
A-1040 Wien, Austria

Sigrid Brell-Cokcan  
Institute of Architectural Sciences, TU Wien  
Karlsplatz 13/259  
A-1040 Wien, Austria

`pottmann@geometrie.tuwien.ac.at`  
`http://www.geometrie.tuwien.ac.at/ig/`